

# FD322 Fiber-Optic Intrusion Detection System

## Specification Sheet

The Fiber Defender™ Model FD322 is a value-priced, easy-to-use, high-performance fiber-optic intrusion sensor designed to detect intruders that are cutting through, climbing over, or crawling under a perimeter fence.

Each alarm processing unit (APU, see figure right) supports two zones, and each zone can support up to 500 meters of sensing cable. An optional tamper-proof enclosure is available for easy mounting at the perimeter.

The sensor element is a rugged multimode optical fiber integrated into a specialized cable and installed inside conduit that is attached to the fence using stainless steel wire. This configuration results in an extremely robust fence-mounted sensor that is unaffected by rain, hail, salt spray, or humidity. The fiber optic sensor, cable, and conduit are dielectric and 100% passive so they can be used in areas with high electromagnetic interference and/or areas with flammable/explosive materials.

The fiber-optic sensor is especially applicable to areas frequented by severe thunderstorms and lightning because the optical fiber cable/conduit will not conduct electrical discharge back to the APU, and because the sensing fiber is unaffected by EMI resulting from lightning strikes.



Features	Applications
Two zones per APU, each fully independent and tunable Up to 500 meters of sensing fiber per zone Standard IP communications port Linear sensitivity Simple user interface Automatic adaptive wind rejection	Construction sites Garden centers High-end residences Corporate buildings Manufacturing plants RV/Marine storage



2925 NW Aloclek Drive, #120  
 Hillsboro, Oregon 97124, USA  
 Tel: +1(503)692-4430 • Toll free (US) +1(888)736-7971  
[www.fibersensys.com](http://www.fibersensys.com)

# FD322 ASSEMBLY DIAGRAM

See Detail B

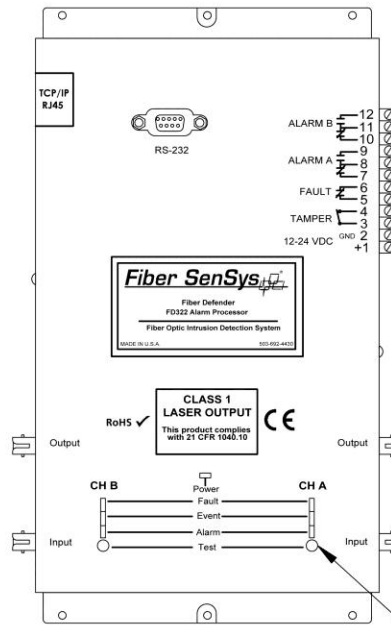
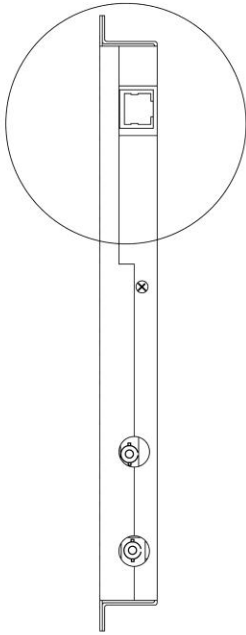

See Detail A

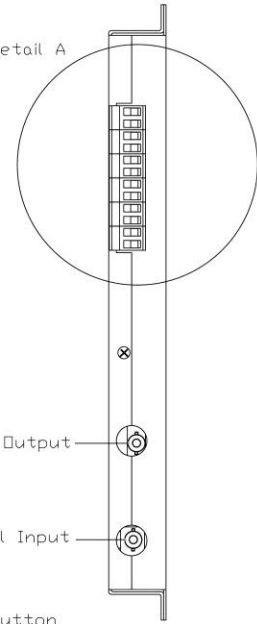

IP/XML Option

DETAIL B

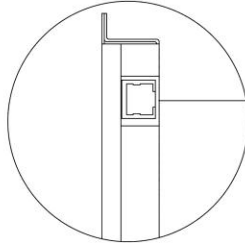

RJ-45 Connector

DETAIL A

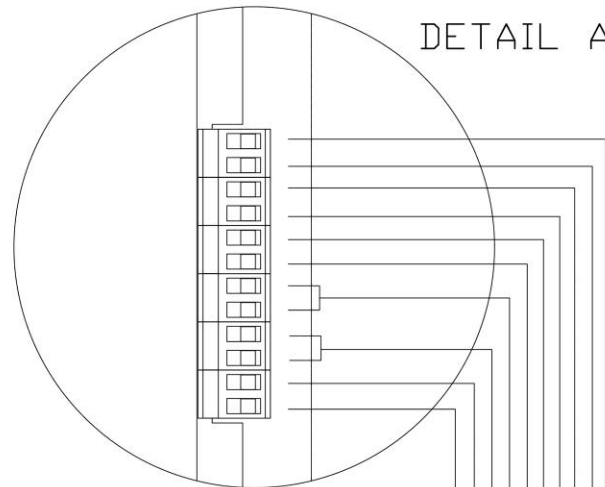

- +12-24 VDC
- Power supply ground
- Tamper switch relay contacts
- Fault alarm relay contacts
- Channel A normally-closed contact
- Channel A common
- Channel A normally-open contact
- Channel B normally-closed contact
- Channel B common
- Channel B normally-open contact

# FD322 ENCLOSURE DIAGRAM

Front View

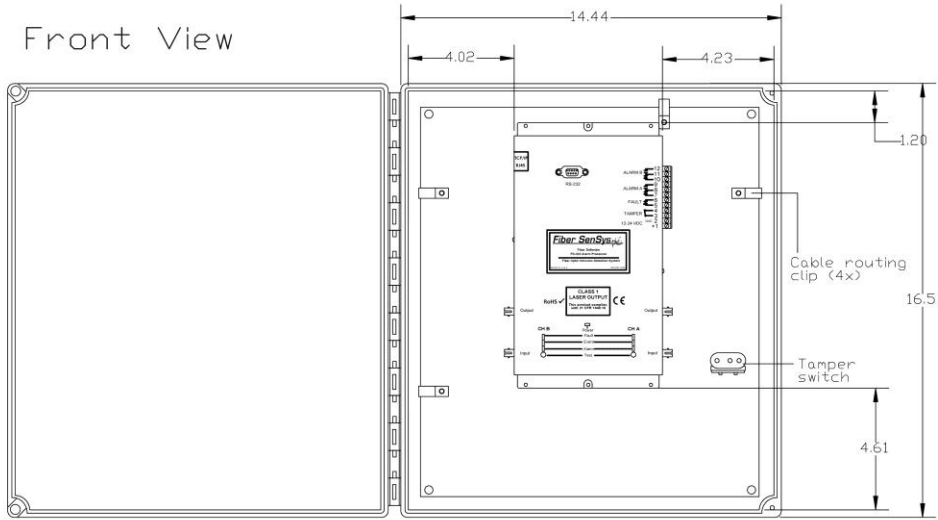

Bottom View

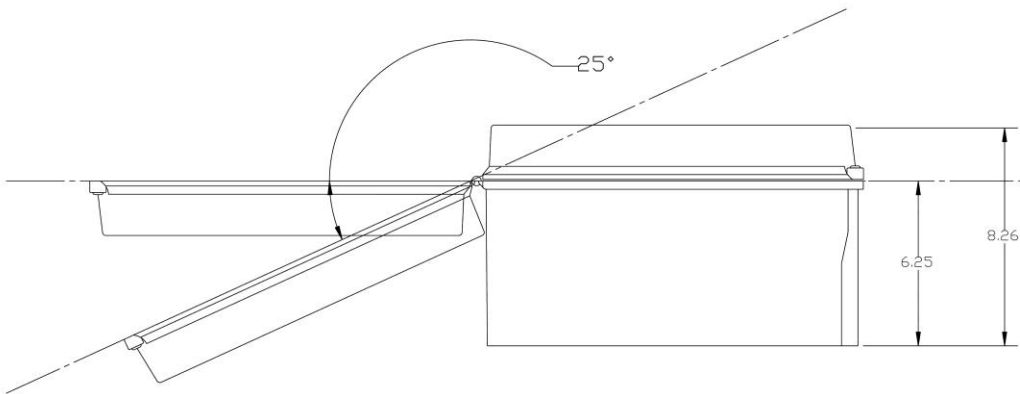

# FD322 APPLICATION BLOCK DIAGRAM

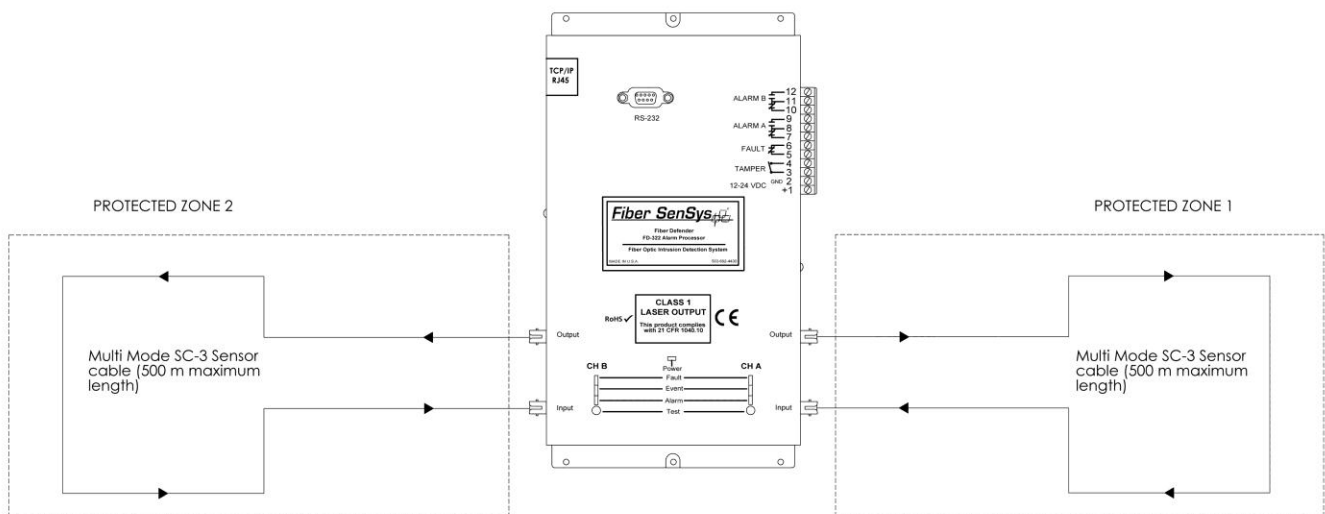

## FD322 PRODUCT SPECIFICATIONS

Application	Perimeter Fence
Sensor	<ul style="list-style-type: none"> <li>• Multimode optical fiber cable</li> <li>• Passive, inert, intrinsically safe</li> <li>• Resistant to EMI and corrosion</li> <li>• -40°C to +70°C operating range</li> </ul>
Installation	<ul style="list-style-type: none"> <li>• Sensing cable in conduit</li> <li>• Conduit attached to fence with wire ties</li> <li>• Loop-back zone configuration</li> </ul>
Insensitive lead-in fiber	No
Number of zones / APU	2
Maximum sensing cable per zone	500 meters
Input power requirements	
Voltage	12-24 VDC
Power	3.0 Watts (250 mA @ 12 VDC)
Programming method	RS-232 using laptop PC
Communications	RS-232 serial communications, IP/XML
Fault and alarm relays	<p>Contact ratings:</p> <ul style="list-style-type: none"> <li>• 28 to 14 AWG</li> <li>• 100 mA, 24 VDC non-inductive</li> </ul> <p>Relay defaults when the APU is in secured status:</p> <ul style="list-style-type: none"> <li>• Fault relay – Normally Closed (NC)</li> <li>• Alarm relay – Normally Open or Normally Closed (NO/NC)</li> </ul>
Light source	<ul style="list-style-type: none"> <li>• Type = laser</li> <li>• Average power = 2 mW max</li> <li>• Wavelength = 1310 nm</li> <li>• Class 1 laser</li> </ul>
Optical connectors	ST, PC polish
APU dimensions	<ul style="list-style-type: none"> <li>• Width: 5.6 in (14.3 cm)</li> <li>• Length: 10.1 in (25.7 cm)</li> <li>• Height: .94 in (2.4 cm)</li> </ul>
Operating temperature range (APU)	-40 °C to +70°C
Operating temperature (sensor)	-40 °C to +85°C
Operating humidity range (APU)	0-90%, non-condensing
Operating humidity range (sensor)	0-100%
Regulatory compliance	CE, FCC Part 15, RoHS
Product compatibility	Fiber Commander™
Tuning parameters	<ul style="list-style-type: none"> <li>• Sensitivity (for cuts and climbing)</li> <li>• Number of events before alarming (for cuts and climbing)</li> <li>• Low-frequency cutoff (cuts/climbing)</li> <li>• Wind rejection</li> <li>• Tamper (enable/disable)</li> <li>• Alarm relay time</li> </ul>

For more information, contact us at  
[info@fibersensys.com](mailto:info@fibersensys.com)  
 Tel: +1(503)692-4430  
 Toll free (US) +1(888)736-7971

**Fiber SenSys**   
 High Performance - High Reliability - High Security